

8500

S E R I E S S P R A Y E R



OPERATION & MAINTENANCE MANUAL

SCHABEN
I N D U S T R I E S .COM

COLUMBUS, NE
800.274.1025

NEWTON, KS
800.394.7662

BAKERSFIELD, CA
877.724.2236

INTRODUCTION

1. Read and understand the Operators Manual and all safety signs before using.
2. Place all controls in neutral, stop tractor engine, turn monitor off, set park brake, remove ignition key, wait for nozzles to stop spraying before servicing, adjusting, or repairing.
3. Before spraying a field, be familiar with all potential hazards: trees, rocks, ditches, gullies, etc. Plan the spraying route to avoid hazards. Remember you are driving a wide machine. **USE CAUTION WHEN CORNERING.**
4. Keep hands, feet, hair and clothing away from all moving and/or rotating parts.
5. Do not allow riders on the sprayer or tractor during operation or transporting.
6. Clear the area of all bystanders, especially children, before starting or filling with water or chemical.
7. Stay away from wing pinch points when folding or extending wings. Keep others away.
8. Stay away from power lines when extending or folding wings. Electrocutation can occur without direct contact.
9. Read chemical manufacturers warnings, instructions and procedures before starting and follow them exactly.
10. Do not breathe, touch or ingest chemicals. Always wear protective clothing and follow safe handling procedures.
11. Spray only when potential for chemical drift is at a minimum. Even small amounts can affect neighboring crops or sensitive plants and people.
12. Dispose of chemical containers by triple rinsing them into the sprayer tank or thoroughly rinsing, crushing and delivering to regional disposal site.
13. In case of poisoning, get immediate medical attention.
14. Only rinse sprayer while still in the field. Spray the rinse thinly over the field already sprayed. Never contaminate the farmyard or drainage systems with sprayer rinse.
15. Do not eat in the field when spraying.
16. Before applying pressure to the hydraulic system, make sure all components are tight and that steel lines, hoses and couplings are in good condition.
17. Before applying pressure to chemical system make sure that all connections are tight and that all hoses and fittings are in good condition.
18. Review safety instructions annually.

PRE-OPERATION CHECKLIST

Before operating the Sprayer and each time thereafter, the following areas should be checked off:

1. Lubricate the machine per the schedule outlined in the "Maintenance Section".
2. Use only a tractor of adequate power and weight to operate the Sprayer.
3. Ensure that the machine is properly attached to the tractor. Be sure that a mechanical retainer is installed through the drawbar pin and the safety chain is attached to the drawbar cage. Jack is properly stowed on bottom side of the tongue.
4. Check the hydraulic system. Ensure that the hydraulic reservoir in the tractor is filled to the required specifications.
5. Inspect all hydraulic lines, hoses, fittings and couplers for tightness. Use a clean cloth to wipe any accumulated dirt from the couplers before connecting to the hydraulic system of the tractor.
6. Check the tires and ensure that they are inflated to the specified pressure.
7. Calibrate the sprayer if it is the start of the season or a new chemical is being used. Calibrate as specified in rate control manual.
8. Check the condition and routing of all chemical hoses and lines. Replace any that are damaged. Re-route those that are rubbing pinched or crimped.
9. Check the spray pattern of each nozzle. Remove and clean or replace any that have an unusual pattern.
10. Remove the steel mesh line filters and wash with clean water. Reinstall.
11. Check that all connections in the electrical system are connected and tight.
12. Remove delivery bolt (see figure 9) on breakaway clamp and ensure wing breaks away freely and returns to locked position. (Delivery bolt should not be reinstalled, for delivery safety only)
13. Before unfolding boom remove transport wing lock pins (see figure 1) and tower cylinder Transport stop (see figure 2) Reinstall lock pins and tower stop before parking sprayer.

14. Consult tractor manufacturers manual for hydraulic operation system.(open or closed center system) For closed center systems, leave hydraulic boom operation block located on the center of boom as factory installed (see figure 4). For open center hydraulic systems, the by-pass (dump) valve needs to be put back in th place of the by-pass (dump) plug (see figure 3).

CONVERTING CLOSED CENTER TO OPEN CENTER HYDRAULIC SYSTEM

- * Standing behind the center of the sprayer looking toward the tractor locate the boom folding hydraulic block .
 - * Locate the by-pass (dump) valve (see figure 4) on the right hand side and the by-pass (dump) plug on left hand side.
 - * Remove both plug and valve.
 - * Reinstall by-pass valve on left hand side and plug on right hand side.
 - * Plug in by-pass valve into 2 pin connector.
15. Inspect boom alignment.
 - * The boom is equipped with set bolt adjustments to provide a means to adjust alignment.
 - * With the boom in field spraying position look down the sprayer boom from end to end and adjust alignment bolts as needed at each hinge.
 - * 6 points should be inspected annually.
 - * Left and right inner boom (see figure 6)
 - * Left and right outer boom (see figure 7)
 - * Left and right break away (see figure 8)

To adjust, loosen jam nut, turn position bolt to the required position and retighten jamnut.

FIG. 1



FIG. 2



FIG. 9

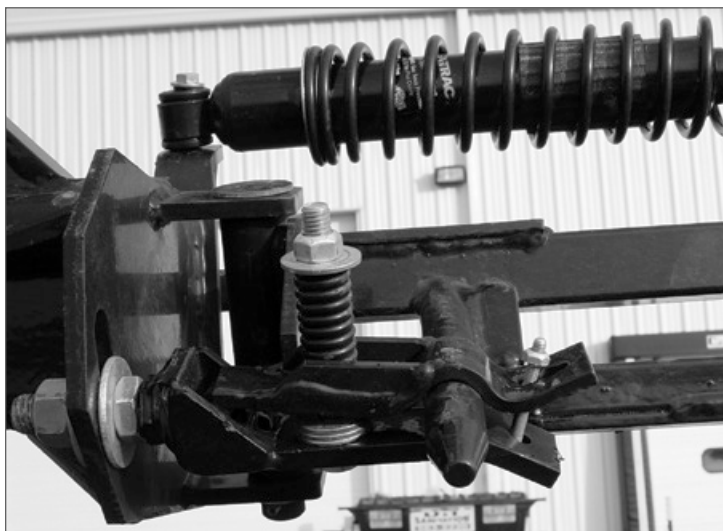

FIG. 3

OPEN CENTER SYSTEM

TOP OF SPRAYER

BOTTOM OF SPRAYER

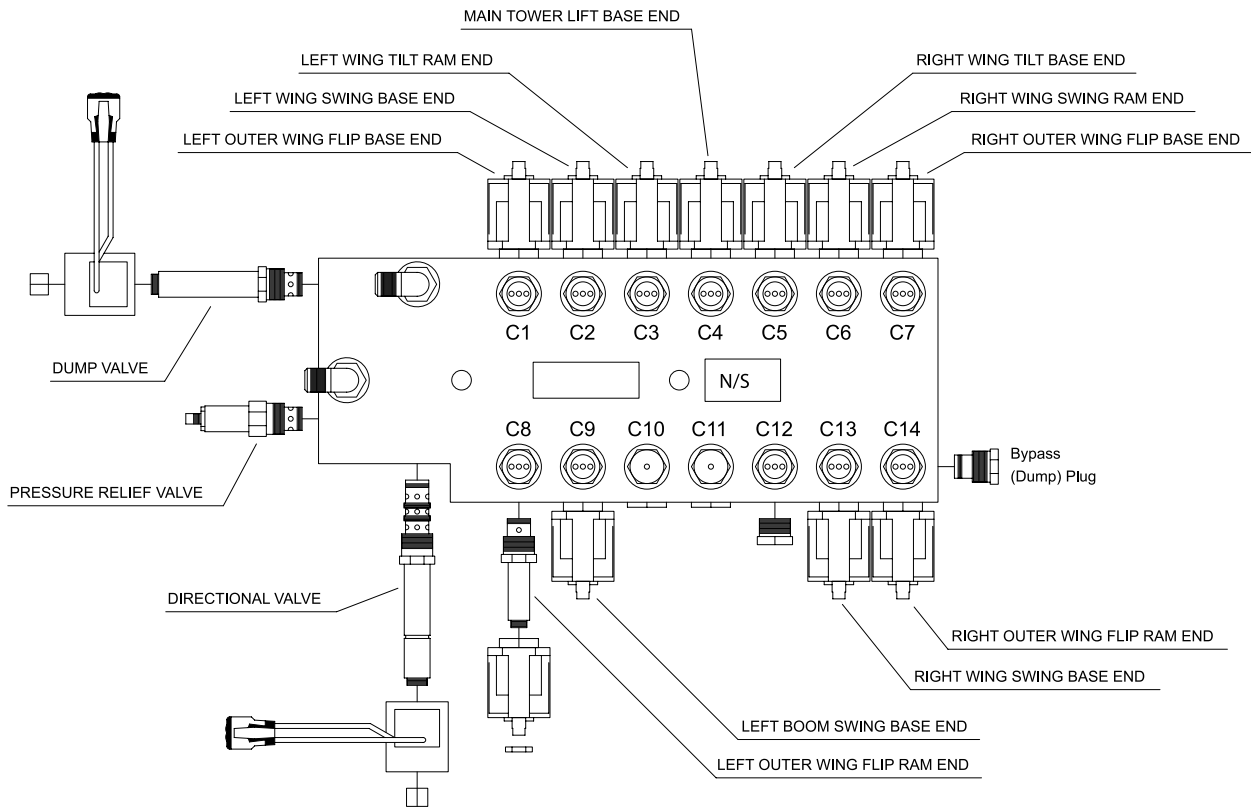
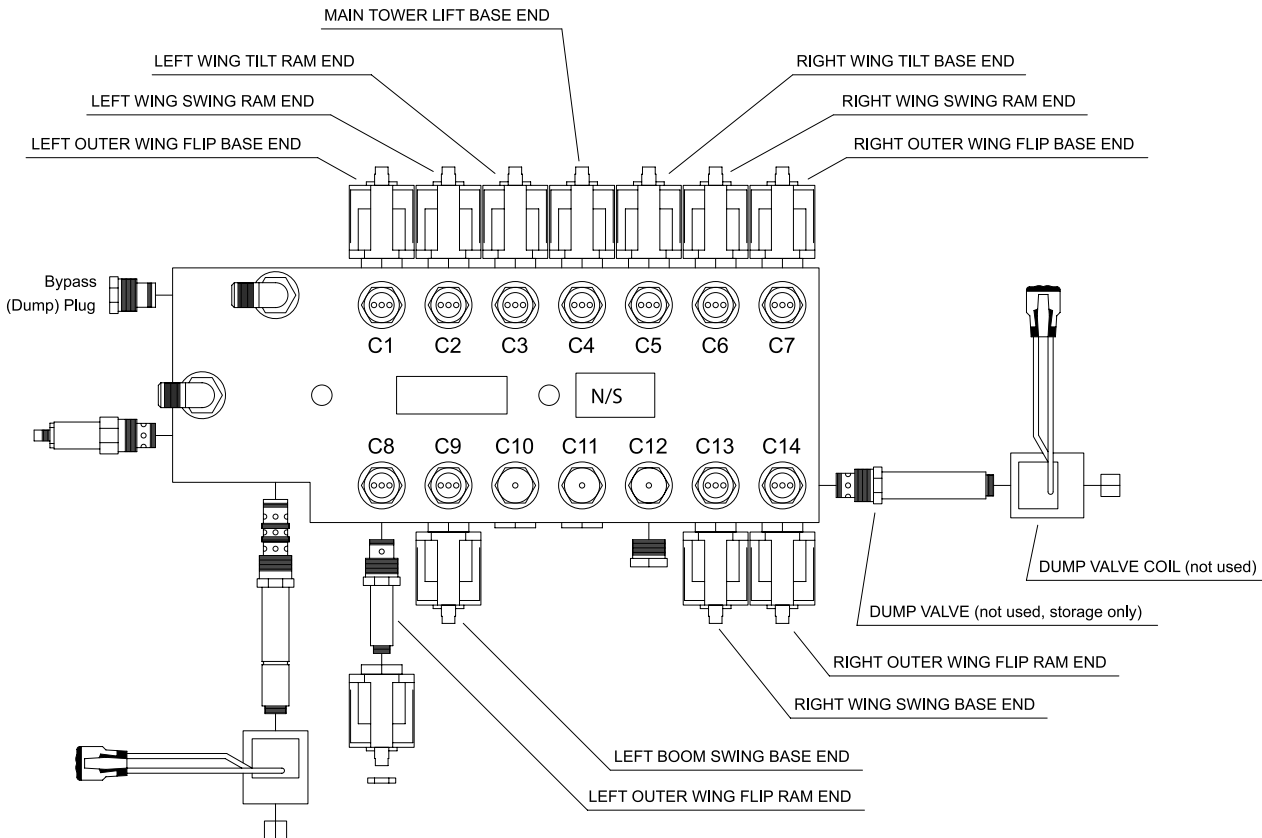

FIG. 4

CLOSED CENTER SYSTEM

TOP OF SPRAYER

BOTTOM OF SPRAYER



SPRAYER OPERATION

FIG. 6



FIG. 7

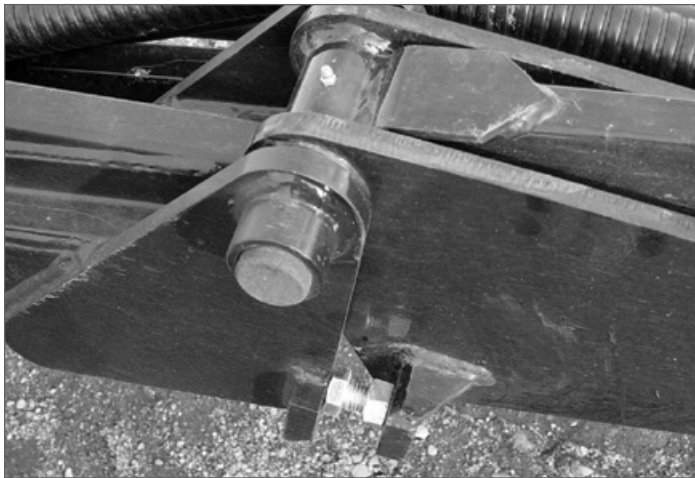
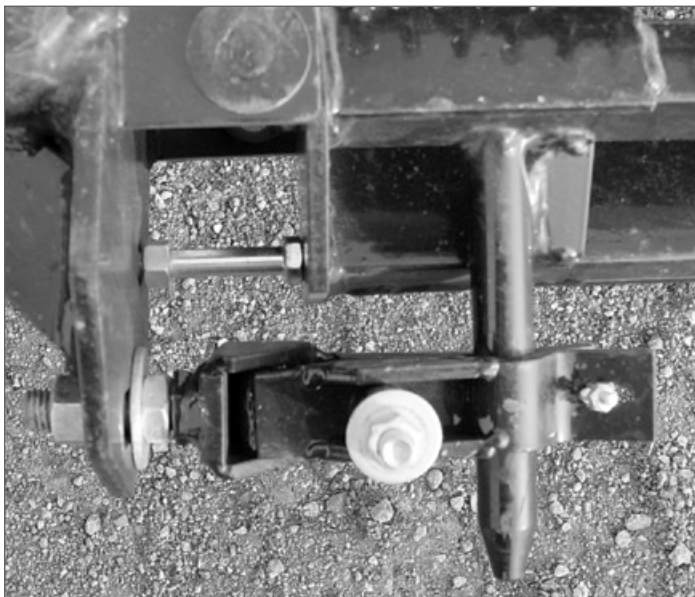

FIG. 8



DO NOT PULL AT ROAD SPEEDS WITH PRODUCT IN MAIN TANK

Electrocution hazard. Keep away from power lines. To prevent serious injury or death from electrocution:

1. Stay well away from power lines when folding or extending wings. Electrocution can occur without direct contact.
2. Lower wings completely before moving or transporting.

BOOM OPERATION

* Mount 7-function control box in a convenient place for easy operator access. Attach to a 12 volt power source (supplied with convenience tractor power plug). Route control cable through tractor cab and plug connectors together and route wiring harness across hitch. *Be sure there are no powerlines next to the machine and the sprayer is located in an open area enough to allow the booms to swing out and fold over without hitting any obstructions. The hydraulic circuit control lever to the boom function circuit must be placed in positive flow position prior to operating. The boom circuit only requires 3 gpm of hydraulic flow. Set hydraulic flow accordingly, increasing hydraulic flow will not speed up boom function. Only reduce sprayer pump and tractor performance.

1. LEFT BOOM TILT POSITION:

This spring-loaded-to-neutral-center toggle switch controls the left boom tilt function. Move the switch up and hold to raise the tip of the left boom and down to lower. Release the switch, the left boom will stop moving and it will remain in position. Use this function to raise the tip of the boom to clear obstructions.

2. BOOM UP/DOWN:

This spring-loaded-to-neutral-center toggle switch controls the boom height cylinders. Move the switch up and hold to raise the entire boom assembly. Move the switch down and hold to move down. Release the switch, the boom will stop and remain at that position. To ensure optimal boom performance never run boom in fully down position. Doing so eliminates boom ride accumulator.

Note: Once tower cylinder bottoms out raise 1" for lowest recommended sprayer height.

FIG.5



3. RIGHT BOOM TILT POSITION:

This spring-loaded-to-neutral-center toggle switch controls the right boom tilt function. Move the switch up and hold to raise the tip of the right boom and down to lower. Release the switch, the right boom will stop moving and it will remain in position. Use this function to raise the tip of the boom to clear obstructions.

4. LEFT BOOM FOLD/EXTEND:

This spring-loaded-to-neutral-center toggle switch controls the left boom position. Move the switch up and hold to fold the left boom and down to extend. Release the switch, the left boom will stop moving and it will remain at that position.

****IMPORTANT****

Extend the cylinder completely when extending the outer boom to eliminate outer wing vibration. To insure the wing is locked down hold the toggle switch down for 5 seconds after the boom is fully extended.

5. LEFT OUTER BOOM SWING:

This spring-loaded-to-neutral center toggle switch controls the left outer boom pivot function. Move the switch up

and hold to pivot the left outer boom in and down to pivot out. Release the switch, the left outer boom will stop and remain at that position.

6. RIGHT OUTER BOOM SWING:

This spring-loaded-to-neutral-center toggle switch controls the right outer boom function. Move the switch up and hold to pivot the right outer boom in and down to extend. Release the switch, the right outer boom will stop moving and it will remain at that position.

7. RIGHT BOOM EXTEND/FOLD:

This spring -loaded-to-neutral-center switch controls the right boom position. Move the switch up and hold to fold the right boom and down to extend. Release the switch, the right boom will stop moving and it will remain in that position.

****IMPORTANT****

Extend the cylinder completely when extending the outer boom to eliminate outer wing vibration. To insure the wing is locked down hold the toggle switch down for 5 seconds after the boom is fully extended.

FIG. 15

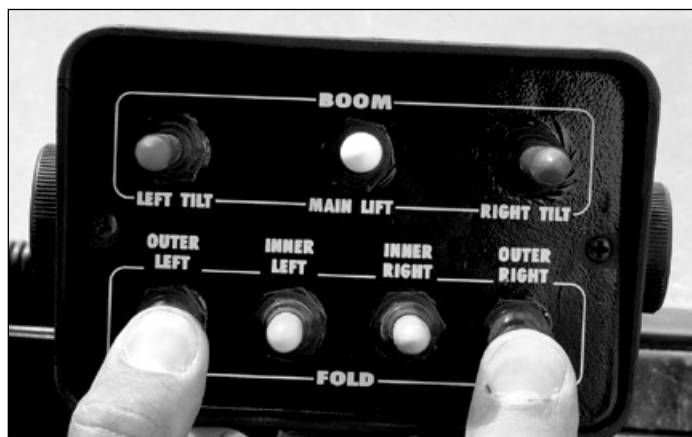

FOLDING/UNFOLDING PROCEDURES

Unfolding boom for field use

****CAUTION****

Electrocution hazard. Keep away from power lines. To prevent serious injury or death from electrocution:

1. Stay well away from power lines when folding or extending wings. Electrocution can occur without direct contact.

2. Lower wings completely before moving or transporting.

Note: Tractor should come to a full stop before folding or unfolding sprayer. Make sure clear of any obstacles overhead or around sprayer that could come in contact with boom.

FIG. 14



1. Before unfolding boom, remove transport using lock pins (see figure 1) and tower cylinder transport stop (see figure 2). Reinstall lock pins and tower stop before transporting sprayer.
2. Raise tilt cylinders by pushing up on “tilt” toggle switch to raise boom out of transport saddle.
4. Hold down on outer fold switches to fold-over outer wings to spray position. Note: Extend the cylinder completely when extending the outer boom to eliminate outer wing vibration. To ensure the wing is

locked down hold the toggle switch down for 5 seconds after the boom is fully extended. (see figure 15)

5. Hold down on “main lift” boom switch to lower boom to desired spray height. To ensure optimal boom performance never run boom in fully down position. Doing so eliminates boom ride accumulator.
6. Reverse the above procedure when converting from field to transport configuration.

IMPORTANT: Once tower cylinder bottoms out raise 1”.

WARNING: Outer fold Booms are a vertical fold and once wing goes past 90° if Air is present in hydraulic system the wing could gravity free fall causing possible personal or boom damage.

The sprayers are hydraulically charged at the factory, but the following procedure should be followed on an annual basis to prevent possible boom drop, from transport position, raise “tilt” wings out of transport saddle, swing the “inner” fold booms 45° out from sprayer frame. Raise “outer” fold wings 80° from inner wing, lower “outer” fold wings to saddle transport position. Repeat 3 times. This cycles the hydraulic lines to prevent air pockets in the hydraulic system to prevent “boom drop”.

PUMP OPERATION

1. Hydraulic pump hoses supplied on the sprayer include 1 - 1/2” line and 1 - 3/4” line. The 1/2” hose is the hydraulic supply (in/pressure) and the 3/4” hose is the return (out/non-pressure).

NOTE: It is recommended for optimal pump performance that the 3/4” return line connect directly to the tractor hydraulic reservoir (not tractor SCV port). Doing so eliminates possible back pressure restriction on the 3/4” return line. Excessive back pressure restriction can cause hydraulic orbital motor damage/failure.

2. Proper sprayer pump disengagement. When shutting off the pump, move the selector to the FLOAT position to allow the centrifugal pump to come to a gradual stop. Standard spool valves, which are found on all tractor hydraulic systems, can cause potentially damaging high peak pressures in the hydraulic system when closed, because of abrupt shutoff of oil flow in both the supply and return lines.
3. Close and lock down the bypass adjusting screw in the hydraulic motor.

Switch rate controller to manual and press the “+” button on TeeJet or “Increase” button on Raven, hold for 8 seconds. Then press the “-” button on TeeJet or “Decrease” button on Raven for 2 seconds.

Set the tractor hydraulic flow control valve for minimum hydraulic oil flow to the remote outlet (Tortoise position).

Start the tractor and allow the hydraulic oil to circulate for approximately 10 to 15 minutes or until adequately warmed.

Prime the centrifugal pump with all valves open.

Open the sprayer control regulating valve and the boom shut-off valves.

Slowly adjust the tractor hydraulic flow control valve until the desired boom pressure is attained.

4. **NOTE: See manufacture pump operators manual for further setup and maintenance.**

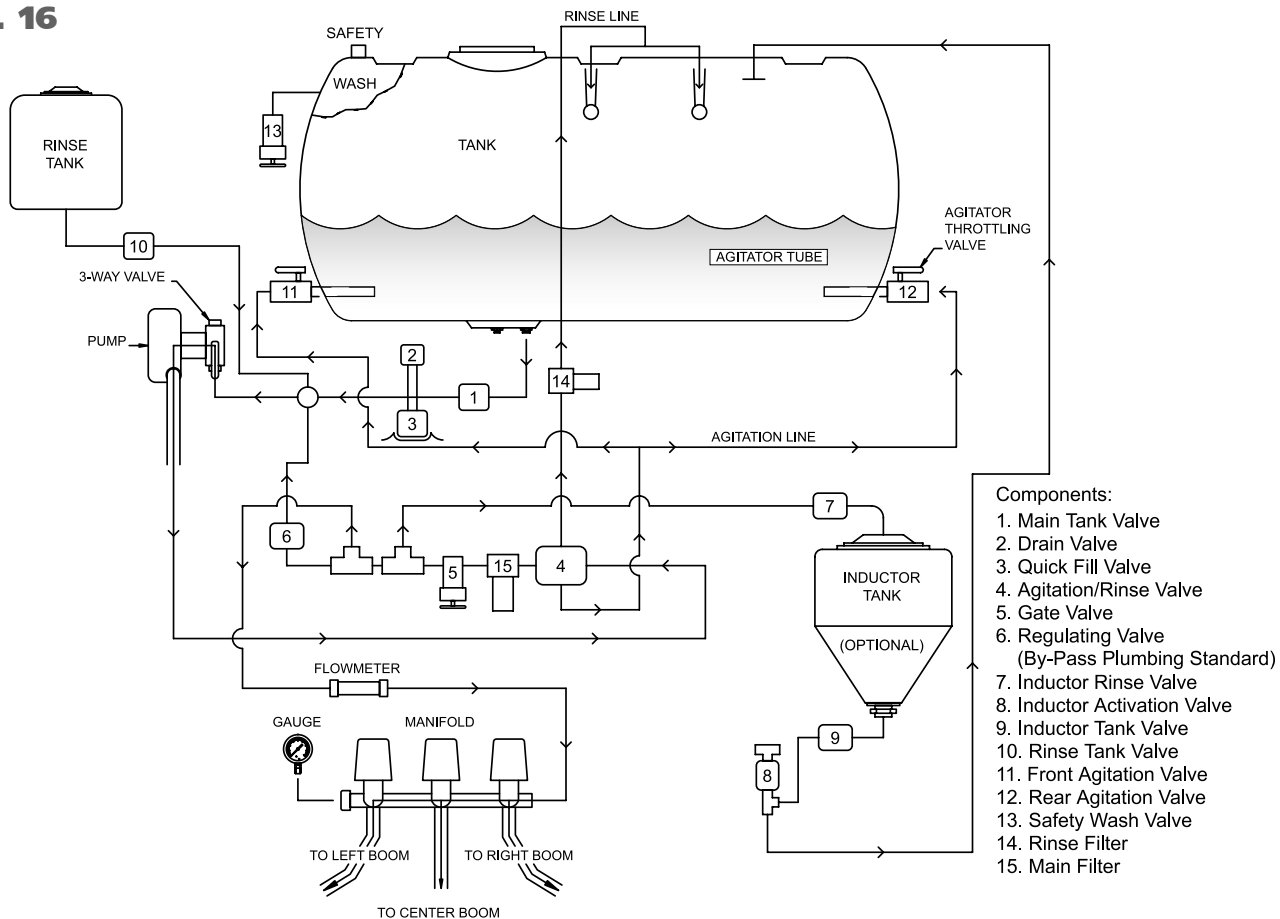
FIG. 16

PLUMBING OPERATION

1. Connect supply hose to quick fill valve (valve 3) (If top filling, open lid and insert supply hose.)

“WARNING!” Be careful if crawling on sprayer. Steel surfaces can become slick when wet. Also watch head while climbing onto sprayer if in transport position. Operator must go under boom to access platform.

2. Make sure main tank valve (valve 1) is open. NOTE: Make sure rinse tank valve (valve 10) is closed before filling. Rinse tank could over run and become chemically contaminated otherwise.
3. Open supply valves and quick fill valve (valve 3) and start filling sprayer.
4. Start sprayer pump and begin circulating solution. (NOTE: make sure sprayer booms are off) Make sure Agitation/Rinse valve is turned with Arrow pointing downward for agitation and agitation valves (valve 11 and valve 12) are open.
5. Make sure manual pressure gauge located on sprayer hand rail has a minimum of 40PSI and not to exceed maximum of 85PSI while filling.
6. With a minimum of 1/2 tank of solution begin to add chemical.

OPTIONAL INDUCTOR: Pull transport pin, release safety latch and gently lower to bottom position. Open Inductor activation valve (valve 8) to start venturi vacuum. Add pre-determined chemical amount to inductor tank and then open inductor tank valve (valve 9) to allow chemical to be pulled into sprayer. (for dry or heavy viscosity products once premeasured, add some solution by opening inductor rinse valve (valve 7) 1/8 turn or as needed to make into a slurry for more efficient induction.) Once chemical has been drawn out open inductor rinse valve (valve 7) 1/4 turn or as needed to rinse chemical residue down for 1 minute or as needed. Close inductor tank valve (valve 9). Repeat above until all chemical is added. When done adding all chemical for spray solution close inductor activation valve (valve 8) and raise inductor tank to transport position, activate safety latch, insert transport pin.

NOTE: For inducing dry flowable products, adjust regulating valve to 60 P.S.I. minimum.

NOTE: Graduation marking on inductor tank are not calibrated. Do Not Use for measuring chemical. Only to be used as a reference point.

NOTE: Make sure inductor rinse tank valve (valve 7) is closed at all times other than when adding chemical.

7. All chemical needs to be added before solution level reaches 3/4 of desired capacity.

NOTE: Follow all chemical manufacture label instructions.

8. When solution reaches desired tank level, close quick fill valve (valve 3) and/or stop solution from being added to sprayer. Disconnect supply hoses, secure all sprayer covers.

9. Continue to run sprayer pump to circulate sprayer solution.

10. Fill auxiliary tanks as needed.
 - Rinse
 - Safety wash
 - Foam Marker

11. Allow solution to circulate for several minutes before applying.

TANK RINSE OPERATION

60 gallon rinse tank located in front of handrail is designed to allow the operator to rinse the sprayer without having to leave the field.

1. Make sure sprayer pump is off.
2. Close main tank valve (valve 1)
3. Open Rinse tank valve (valve 10)
4. Turn pump on make sure boom valves are off. Manual pressure gauge on front of the sprayer needs to read between 50 and 75PSI (see sprayer controls for adjustment procedure)
5. After allowing sufficient time for agitation lines to rinse then turn agitation/rinse valve (valve 4) 1/2 turn so arrow points upward to activate rinse balls.
6. Run pump until rinse tank is empty.
7. Shut pump off.
8. Close rinse tank valve (valve 10)
9. Open main tank valve (valve 1)

10. Turn agitation/rinse valve (valve 4) 1/4 turn so arrow points horizontal and both lines are off.

11. Lightly spray rinse solution over pre-sprayed area.

12. Shut off pump and booms when tank is empty.

13. Repeat as needed when changing chemicals.

NOTE: Recommendation that a chemical neutralizer be run through the rinse system between different chemical usages. Follow procedures stated above. Rinse with water following chemical neutralizer before adding chemical.

OPTIONAL: Rinse Boom plumbing while chemical still in tank.

- 1a. Close agitation/rinse valve(valve 4)to horizontal position (shutting off both lines).
- 2a. Start sprayer pump, open boom valves and dispense lightly over pre-sprayed area.
- 3a. Run until adequately rinsed.

SPRAY CONTROLLER OPERATION

1. See spray controller manufactures manual for proper installation and setup.
2. Once controller is installed according to manufactures recommendations test the system with water.
3. Add a couple hundred gallons of water unfold boom in a safe area according to folding/unfolding procedures (page 5)
4. Engage pump per pump operation (page 6)
5. Turn master boom switch to the on position.

6. Turn individual boom switches on one at a time cycling on and off to make sure each is operating properly.
7. With master switch on and all individual boom switches on, cycle pressure up and down (in manual mode if using an automatic rate controller) to determine spraying pressure range.(see pump operation page 6 for further instruction)
8. Repeat #7 with master switch on and individual booms off. This may be required to be done to attain recommended PSI for proper operation of optional inductor tank (see page 7) and rinse system. (see page 8).

OPTIONAL SPRAY CONTROLLER SPEED SENSOR

FIG. 17

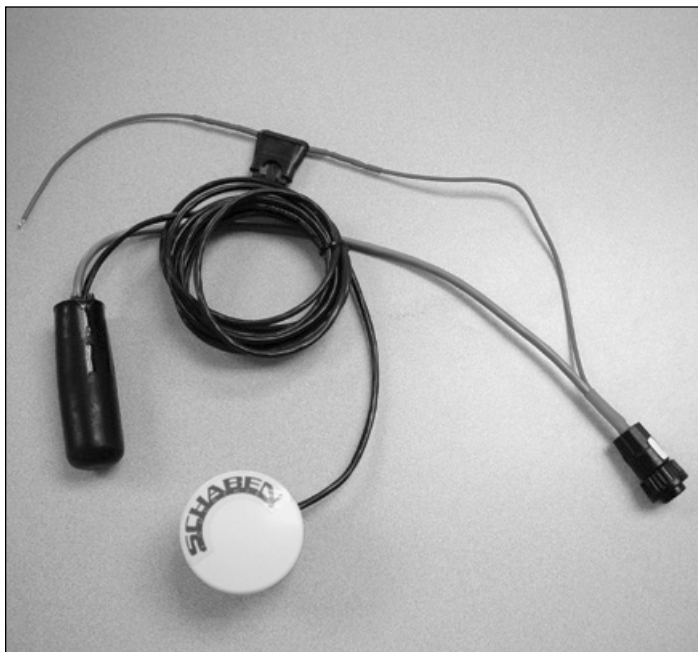

If equipped with an automatic rate controller, a speed sensor is sent along in the controller kit. The sensor needs to be mounted to the cap or sprayer with a clear line of sight to the sky. The red wire will need to be hooked up to 12 volt power (TeeJet cal #1150. Raven cal # 586. See figure 17).

LADDER & TOOL BOX

FIG. 19



LADDER

Raise the ladder into the vertical position and push over and down to secure in the locked position. The lock is part of the ladder anchor bracket. Position the ladder in the up and locked position whenever the sprayer will be moved. (see figure 19)

TOOL BOX

The platform of the machine is designed to provide storage for the operator. Lift the floor of the platform to access the storage compartment. (see figure 18)

FIG. 18

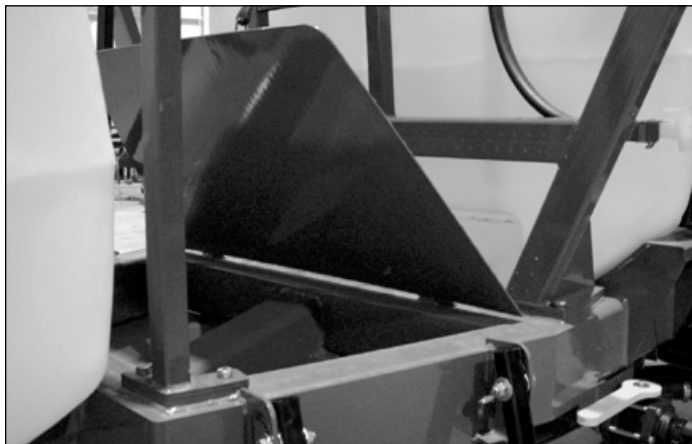

OPTIONAL FOAM MARKER OPERATION

1. Route the 20' split harness and control box to the operator's desired location. ****Make sure the cable does not contact any hot, sharp or moving objects to avoid shorts and breaks****
2. Connect the red and white wires directly to the battery. **DO NOT CONNECT** the power wires through any fuse or switch boxes on the tractor,

this will cut down on amps to the marker
(see figure 11)

*On units with 12 volt batteries, contact the red lead to the positive post and the white lead to the negative post.

**On units with two 6 volt batteries, connect the red lead to the positive post that feeds the starter and the white lead to a clean chassis ground.

FOAM MARKER WINTER STORAGE

1. When unit is stored during freezing temperatures, drain unused foam solution from tank (disconnect air pump and run liquid pump until unit is near empty), fill tank with

enough foam marker anti-freeze to cover bottom of suction hose. Then run unit until antifreeze is going into pvc mixing chambers.

INITIAL START-UP

1. Follow label instructions for proper mixing of foam concentrate. Fill tank with desired amount of water and then add foam according to label. It is better to have more foam concentrate added to the water than less, because liquid flow amount can be regulated by Wet/Dry knob.

NOTE: Start with control knob at center position.

2. To start foamer: turn main power switch to on position then switch the toggle switch to the left or right position.

Foam will travel from the control valve (144f-1-3) toward the right or left side of the boom. Reverse the L/R toggle switch and foam will travel the opposite direction. (see figure 10)

NOTE: If liquid pump does not prime on start up, run Wet/Dry control at full wet until prime.

TROUBLE SHOOTING

1. If foam is soupy, set more to dry on foamer control or more foam concentrate needs to be added to the water. (concentrates for pressurized tank systems are not recommended for use with SI foam markers)

2. Water conditions (soft or hard) will also vary foaming action. Your local coop will probably be able to advise which foam concentrate works best with local water conditions.

3. If a change of drop rate is desired: adjust knob more toward wet until desired rate is achieved.

4. Drops are too far apart or you are doing post emerge work and can not see drops do to plant height: Remove rubber boot from end of drop hose to get a nearly straight stream of foam at end of boom.

NOTE: If you are having trouble seeing foam try either Tracer Pink (hot pink) or Tracer Blue colorants from Schaben Industries.

FIG. 10

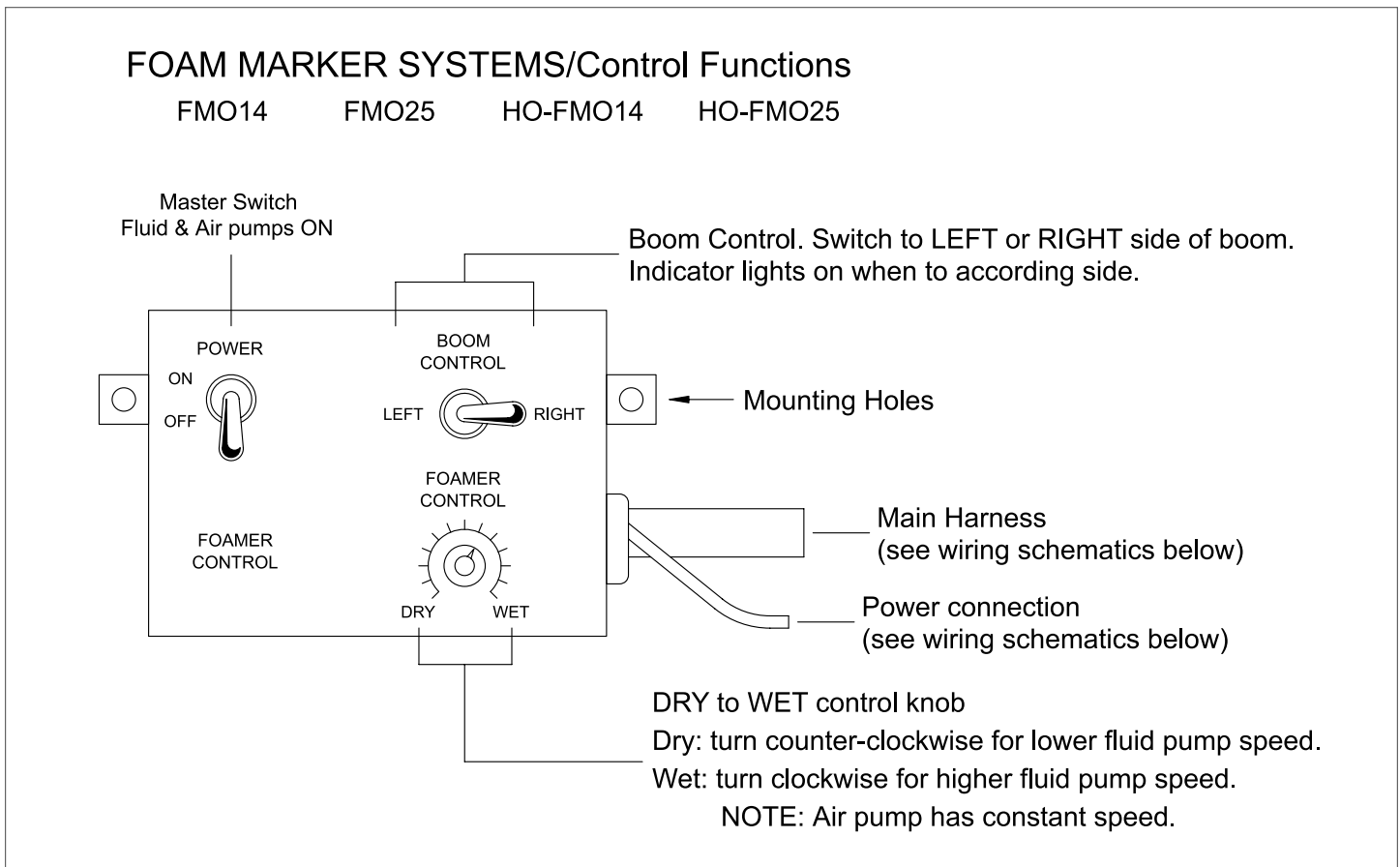
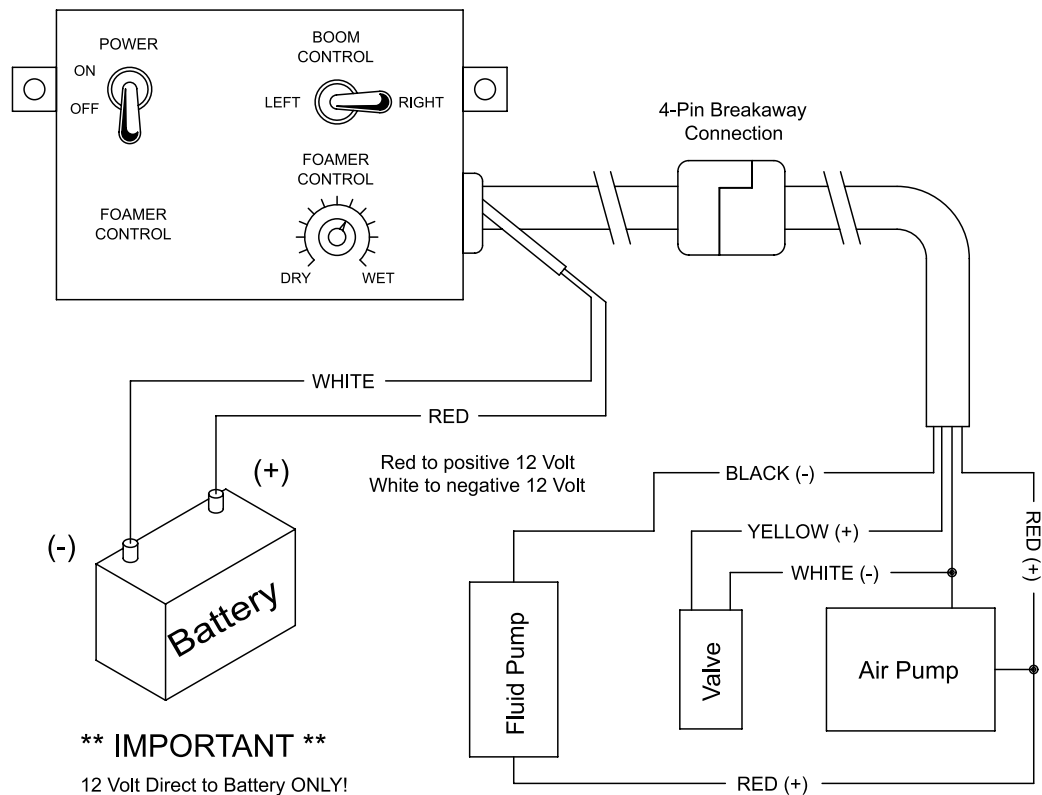

FIG. 11**FOAM MARKER SYSTEMS/Control Functions**

FMO14 FMO25 HO-FMO14 HO-FMO25

**** IMPORTANT ****

12 Volt Direct to Battery ONLY!
DO NOT GO THROUGH
FUSE BOXES or POWER STRIPS!

BREAK-IN

Although there are no operational restrictions on the sprayer when used for the first time, it is recommended that the following mechanical items be checked:

A. After operating for 1/2 hour

1. Re-torque all the wheel bolts.
2. Re-torque all other fasteners and hardware.
3. Check that all electrical connections are tight.
4. Check that no chemical or hydraulic lines are being pinched or crimped. Re-align as required.

5. Check that all nozzles are working properly. Clean or replace as required.

6. Lubricate all grease fittings.

B. After 5 hours and 10 hours of operation

1. Retorque all wheel bolts, fasteners and hardware.
2. Check chemical and hydraulic line routing.
3. Check that all nozzles are working properly.
4. Then go to the normal servicing and maintenance schedule as defined in the Maintenance Section.

SERVICE AND MAINTENANCE**! MAINTENANCE SAFETY!**

1. Review the Operator's Manual and all safety items before working with, maintaining or operating the sprayer.

2. Place all controls in neutral, stop the tractor engine, turn monitor off, set park brake, remove ignition key, wait for nozzles to stop spraying before servicing, adjusting, repairing or unplugging.

3. Follow good shop practices:
 - Keep service area clean and dry
 - Be sure electrical outlets and tools are properly grounded
 - Use adequate light for the job at hand.
4. Before applying pressure to a hydraulic system, make sure all components are tight and that steel lines, hoses and coupling are in good condition.
5. Before applying pressure to chemical system, make sure that all connection are tight and that all hoses and fittings are in good condition.
6. Relieve pressure from hydraulic circuit before servicing or disconnecting from tractor.
7. Keep hands, feet, clothing and hair away from all moving and/or rotating parts.
8. Clear the area of bystanders, especially children, when carrying out any maintenance and repairs or making any adjustments or filling.
9. Place stands or blocks under the frame before working beneath the machine.
10. Wear safety goggles, neoprene gloves and protective clothing when working on the sprayer filled with active chemical.
11. Wash machine to remove all chemical residue before working on unit. Wear appropriate protective gear at all times.
12. Protect yourself from chemical contamination.

GREASING

- Wipe grease fitting with a clean cloth before greasing to prevent injecting dirt and frit into joint.
- Replace and repair broken fittings immediately.
- If a fitting will not take grease, remove and clean thoroughly. Also clean lubricant passageway. Replace fitting if necessary.

***Note: Grease 19 points 8 hours or daily.**

FIG. 20a

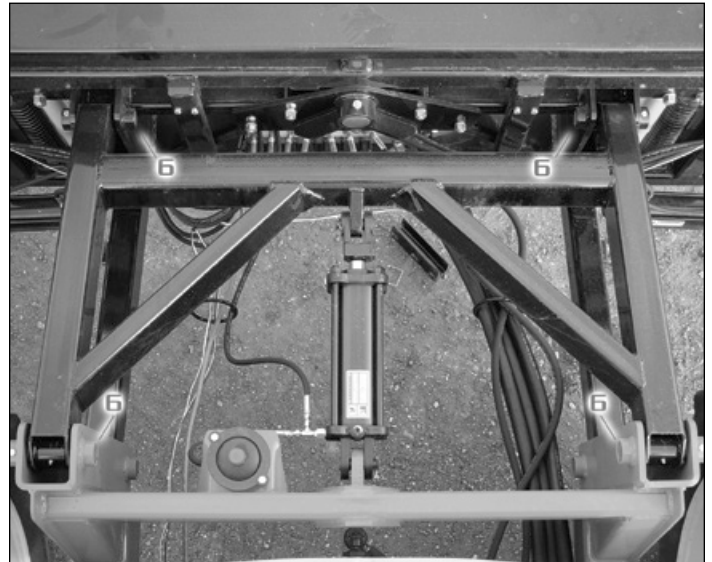

L/R GREASE LOCATIONS

Apply adequate grease to the following:

1. L/R Breakaway Hinge
2. L/R Outer Boom Hinge
3. L/R Inner Boom Hinge
4. L/R Center Section Bushing (Lower)
5. L/R Center Section Bushing (Upper)
6. Parallel Hinge Bushings (Total of 8)
(4 Top Pins & 4 Bottom Pins)
7. Center Pivot Pin

FIG. 20b

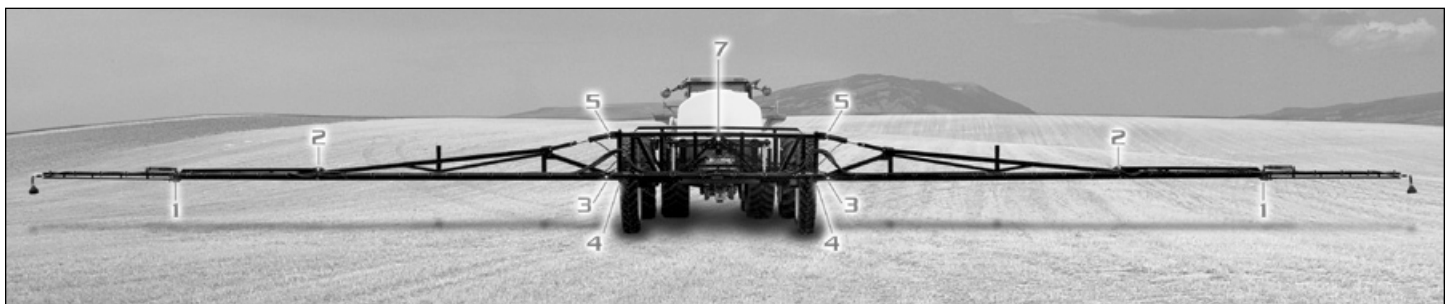

SPRAY CONTROL VALVE WIRING





							Controller Wiring Diagram
<u>12 V+</u>	<u>Ground</u>	<u>Section 5</u>	<u>Section 4</u>	<u>Section 3</u>	<u>Section 2</u>	<u>Section 1</u>	
Red	Black	Gray	Yellow	Green	Brown	White	TeeJet 844 & 854
Red	Black	-	-	Orange	Yellow	Green	TeeJet 734 & 744
Red	White	-	-	Blue	Brown	Black	Raven 330 & 440
Red	White	Wht/Brwn	Black/Wht	Blue	Brown	Black	Raven 440 & 450

FIG. 12

- The motorized ball valves equipped on the sprayer require 12V⁺ constant power and ground to make actuate. When 12V⁺ is sent from the controller thru the signal wire per each section the valve will open as long 12V⁺ is present to the section wire. Once power is removed by turning off the individual or master switch, the valves will close.

- Each motorized ball red wire connects to the 12V⁺ terminal. Each motorized ball valve black wire will connect to ground terminal, and each motorized ball valve white wire will connect to the corresponding section terminal.

MAINTENANCE

FILTER CLEANING

The fluid in the sprayer is continually being filtered through a screen filter. The sprayer must have clean water to prevent clogging of the screens and check valves when in use. These screens must be cleaned daily or more often as required. To clean, follow this procedure:

1. At the start of each day before the water and chemicals are added, the screens should be checked and cleaned.
2. If there is water or solution in the sprayer, close valve 1 (figure 22, page 8) and valve 4 (figure 21) to isolate the screens.
3. Loosen the filter bodies by hand. Do not use a wrench as this could damage the filter body.
4. Remove the screens and inspect them for foreign material.

5. Clean them using clean water.
6. Inspect for holes or tears. If there is damage, replace.
7. Install the screens and body to the filter heads and tighten by hand. Do not use a wrench as this might damage the body. Do not overtighten and crack the head.
8. Open valves 1 & 4 to allow the solution to circulate.
9. Drain all screens before storage to avoid freezing.

FIG. 13



FIG. 21



PLACING IN STORAGE

At the end of the spray season, the machine should be thoroughly inspected and prepared for storage. Repair or replace any worn or damaged components to prevent any unnecessary down time at the beginning of the next season. Follow this procedure:

1. Thoroughly wash the machine using a hose or a pressure washer to remove all dirt, mud, debris or residue.
2. Thoroughly wash the inside of the tank and spray system with the wash cycle to remove all chemical residue using the method described in the Tank Rinse operation.
3. In climates that encounter freezing temperatures during the storage period, the following preparation should be done:
 - a. Add 10 gallons (40 liters) of a 50:50 mixture of potable RV antifreeze to the tank.
 - b. Run unit for 5 minutes in the wash and spray cycles to circulate solution to all parts of the circuit.
 - c. While circulating the fluid, open and close all the valves in the chemical and eductor tank circuits several times to flush all the water from the system.
 - d. Draw the solution out of the chemical tank.
 - e. Flush the solution out the booms.
4. Lubricate all grease points. Make sure all grease cavities have been filled with grease to remove any water residue from the washing.
5. Inspect all the hydraulic hoses, couplers and fittings. Tighten any loose fittings. Replace any hose that is badly cut, nicked, abraded or is separating from the crimped end of a fitting.
6. Inspect all the spray hoses and fittings. Tighten any loose fittings.
7. Replace any hose That is badly cut, nicked, abraded or is separating from a fitting.
8. Touch up all paint nicks and scratches to prevent rusting.

STORAGE SAFETY

1. Store unit in an area away from human activity
2. Do not permit children to play on or around the stored sprayer
3. Unhook and store in the transport configuration.

REMOVING FROM STORAGE

When removing from storage and preparing to use, follow this procedure.

1. Clear the area of bystanders, especially small children, and remove foreign objects from the machine and the working area.
2. Check
 - a. Tank for cracks
 - b. Tank hold down hardware
 - c. All hardware. Tighten as required.
 - d. Tire pressure.
 - e. All sprayer and hydraulic lines, fittings and connections. Tighten as required.
3. Lubricate all grease fittings.
4. Replace any defective parts.
5. Fill the tank with 20 gallons (75 liters) of clean water and run for 5 minutes in the wash cycle. Open and close all valves several times. Flush water through the booms.
6. Repeat step 5.
7. Calibrate the pump, nozzles and sprayer before using.
8. Go through the pre-field checklist before using.

LIMITED WARRANTY

Schaben Industries warrants to the buyer that the new machinery is free from defects in material and workmanship.

This warranty is only effective as to any new machinery which has not been altered, changed, repaired or treated since its delivery to the buyer, other than by Schaben Industries or its authorize dealers or employees, and does not apply to accessories, attachments, tools or parts, sold or operated with the new machinery, if they have not been manufactured by Schaben Industries.

Schaben Industries shall only be liable for defects in the materials or workmanship attributable to faulty material or bad workmanship that can be proved by the buyer, and specifically excludes liability for repairs arising as a result of normal wear and tear of the new machinery or in any other manner whatsoever, and without limiting the generality of the foregoing, excludes application or installation of parts not completed in accordance with Schaben Industries operator's manual, specifications or printed instructions.

Written notice shall be given by registered mail, to Schaben Industries within seven (7) days after the defect shall have become apparent or the repairs shall have become necessary, addressed as follows: Schaben Industries, 5834 East 23rd Street, Columbus, NE 68601.

This warranty shall expire 2 years after the date of delivery of the new machinery.

If these conditions are fulfilled, Schaben Industries shall at its own cost and at its own option either repair or replace any defective parts provided that the buyer shall be responsible for all expenses incurred as a result of repairs, labor, parts, transportation or any other work, unless Schaben Industries has authorized such expenses in advance.

The warranty shall not extend to any repairs, changes, alterations, or replacements made to the new equipment other than by Schaben Industries or its authorized dealers or employees.

This warranty extends only to the original owner of the new equipment.

Rubber parts are not warranted. (including tires, hoses, grommets)

This warranty is limited to the terms stated herein and is in lieu of any other warranties whether express or implied, and without limiting the generality of the foregoing, excluded all warranties, express or implied or conditions whether statutory or otherwise as to quality and fitness for any purpose of the new equipment. Schaben Industries disclaims all liability for incidental or consequential damages.

This sprayer is subject to design changes and Schaben Industries shall not be required to retro-fit or exchange items on previously sold units except at its own option.

8500

S E R I E S S P R A Y E R



Form 1053

OPERATION & MAINTENANCE MANUAL

SCHABEN
I N D U S T R I E S .COM

5834 EAST 23RD STREET
COLUMBUS, NE 68601
800.274.1025

P: 402.564.4544 • F: 402.564.0549
COLUMBUS@SCHABENINDUSTRIES.COM

7000 SCHABEN COURT
NEWTON, KS 67114
800.394.7662

P: 316.283.4444 • F: 316.283.4646
NEWTON@SCHABENINDUSTRIES.COM

4450 STATE ROAD
BAKERSFIELD, CA 93308
877.724.2236

P: 661.391.9081 • F: 661.391.9085
BAKERSFIELD@SCHABENINDUSTRIES.COM