

2" Poly Wet Seal Pump

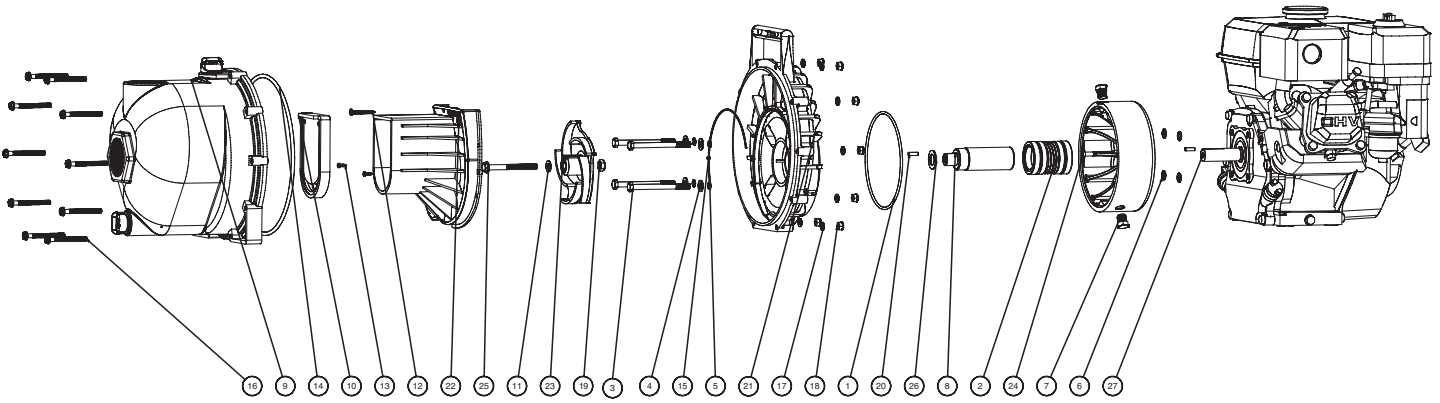

ITEM	DESCRIPTION	QTY.	2" PUMP
1	O-Ring	1	13719
2	Seal Assembly for wet seal pump	1	15035
3	5/16-24 x 3 3/4" HHCS	4	12034
4	5/16" Flat Washer	4	12901
5	O-Ring for Brkt screw	4	12717
6	O-Ring	4	12709
7	1/4" Drain Plug	2	17032
8	Adapter Shaft	1	12155
9	2" Pump Body Assembly	1	12712A
10	Check valve	1	12705
11	Impeller Bolt Gasket	1	12774VA
12	#10 x 1 1/2" PPH SMS	1	12900
13	#6 x 1/2" PPH SMS	2	12725
14	Pump Body O-Ring	1	12719A
15	O-Ring Segment	1	12754
16	1/4-20 x 2 1/2" SL IND HWHS	10	12720
17	1/4" Lock Washer	10	V07018
18	1/4-20 Hex Nut	10	V07019
19	7/16-14 Hex Nut	1	12775A
20	3/16" SQ. x 5/8" Key	2	12902A
21	2" W.S. Rear Bracket	1	12707W
22	2" Poly Pump Volute	1	12702A
23	Impeller	1	12772
24	2" Poly Reservoir	1	12202W
25	5/16-24 x 3 1/4" HFS	1	12766
26	Gasket	1	CV10175
27	5 HP Honda engine	1	E5H

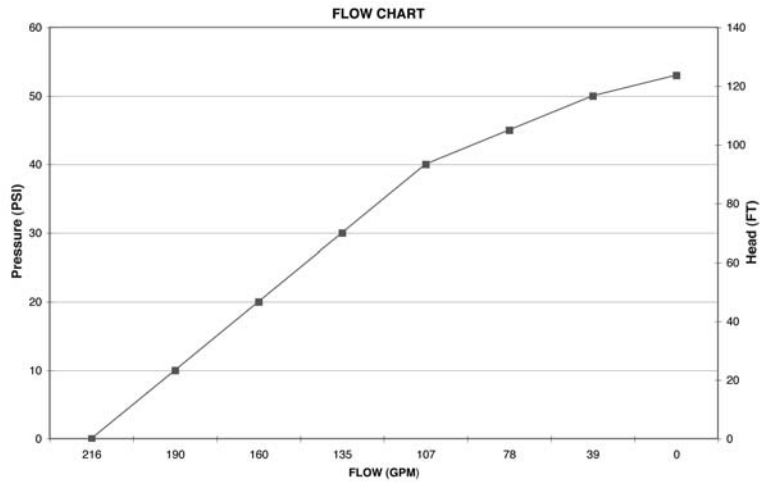



2" & 3" Poly Wet Seal Pump Instruction Manual

Read these instructions and the instructions covering operation of the pump drive unit. Do not operate the gas engine (if so equipped) until you have put oil in the engine. Do not operate the wet seal pump until you have filled the wet seal reservoir 3/4 full (the seal assembly should be submerged) with a 50% ethylene glycol (anti-freeze) and 50% water mixture. Do not run the pump dry. Always fill the pump with water or the fluid being pumped before starting the drive unit to avoid premature pump seal failure.

The gas engine (if so equipped) is shipped with no oil in it. Consult your engine owners manual for specific oil recommendations and maintenance procedures. For engine warranty service contact your local engine dealer.

Make certain that all hose and pipe connections are air tight. An air leak in the suction line may prevent priming and will reduce the capacity of the pump.

Always place the pump as close to the liquid to be pumped as possible. Keep the suction line short and with few bends. Keep the pump and engine on a level foundation. A poor foundation and a heavy suction hose (made heavier when "primed" full of liquid) could result in a pump "down the hole". It is not necessary to drain the pump body after use, unless there is a danger of freezing.

There are important instructions regarding the preparation of the engine for long periods without use. (Reference the engine instruction manual.) Under these conditions, drain the pump. Leave all plugs (fill and drain) out of the pump. Always store the pump unit in a heated, dry building.

When pumping dirty water or liquids containing solids, always use a pump strainer on the end of the suction line.

There are no points on the pump that need lubrication. The pump seal is cooled and lubricated by the fluid being pumped.

WARNING! Do Not use with Flammable Liquids.

Do not pump flammable liquids or other hazardous liquids with this pump. Failure to follow this warning can result in explosion, serious bodily injury or death. For safe operation read and follow the safety precautions in the following owners manual.

*Note: Engine warranty service available at authorized Briggs & Stratton and Honda dealers.



DISASSEMBLY INSTRUCTIONS:

1. Remove the 10 body screws, lock washers and nuts from the pump assembly. Remove the body from the pump assembly.
2. Remove the check valve from the volute. Remove the one upper volute screw and the two smaller volute screws from the volute.
3. Remove the volute from the remaining pump assembly.
4. Remove the impeller bolt from the impeller. Remove the impeller bolt gasket from the impeller.
5. Screw the supplied 7/16-14 hex head cap screw into the impeller snout. As the bolt is tightened the impeller will be pried off of the shaft of the drive unit. Remove the 7/16-14 screw once the impeller has been removed from the drive unit.

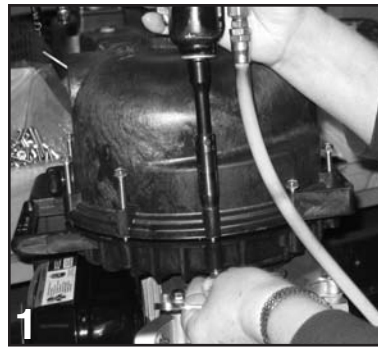

6. Remove the four bracket screws, rear bracket washers, and screw head O-rings from the rear bracket using a 1/2" socket. With the four bracket screws removed the rear bracket and reservoir can now be removed from the drive unit.

*Take note of o-rings between reservoir and drive unit.

7. Remove the seal half from the rear bracket. This may be done by using a round object such as a wrench socket and pressing it out. The seal is very fragile so take care not to crack the seal if it will be reused. Repeat the procedure for removing from reservoir.

With the pump completely disassembled; clean all of the reusable parts thoroughly, removing any traces of old gasket material and trapped or dried liquids that were run through the pump.

At this time, it may be necessary to polish the drive unit shaft to remove any corrosion that may have formed.

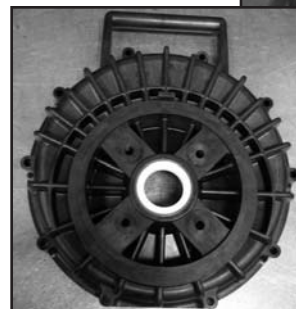
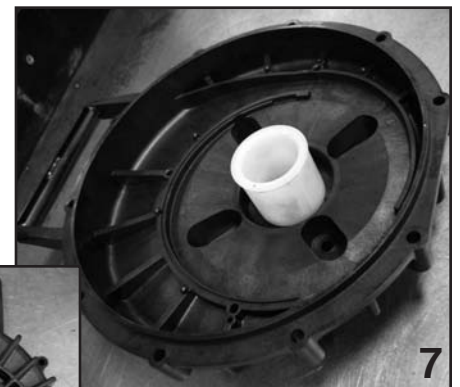

ASSEMBLY INSTRUCTIONS

1. Install drive unit key (image 1a) & adapter shaft on drive unit shaft (image 1b).

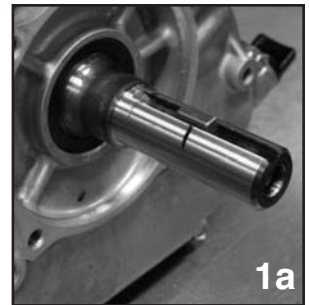

2. The seal half should now be installed into the rear bracket (image 2a) and reservoir (image 2b) as shown. To install the seal half into the rear bracket use a tool such as a 1 1/2" pipe nipple or arbor press to give even pressure on the metal flange of the seal housing during installation. Gently press the seal into position until it bottoms as shown at right.

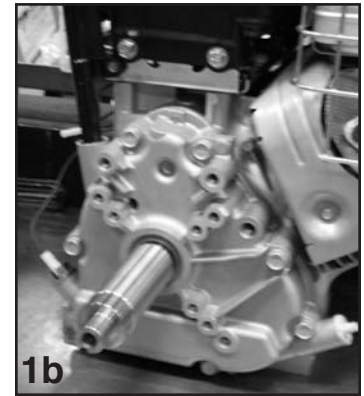

3. Clean the threads of the bracket screws thoroughly. Once clean, install the four flat washers and four screw head O-rings onto each of the bracket screws.



4. Install o-rings in grooves in back of reservoir. Use a dab of grease to hold in place.



5. Place reservoir over adapter shaft. Slide seal over shaft as shown at left.

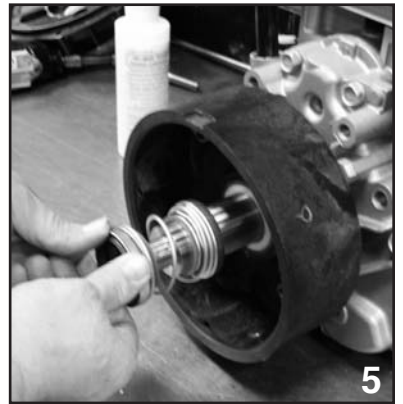

6. Install body and reservoir o-rings onto rear bracket.

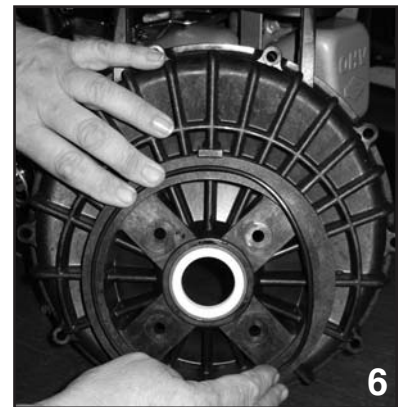



7. Install the rear bracket onto the drive unit using the bracket screw assemblies from the previous step (image 7a).

The handle of the rear bracket should be to the top of the drive unit. Tighten the screws securely (torque between 80-100 in/lbs).

Install drive unit key (image 7b).

Verify that the impeller hex nut is located at the bottom of the impeller snout (if required), it should be installed now. A very light press fit may be required to install the nut into its cavity (image 7c).



8. Install o-ring segment onto rear bracket.



9. The impeller is now ready to be slid onto the drive unit shaft (9a image). Secure the impeller to the drive unit shaft with the impeller bolt gasket and impeller bolt. Tighten the impeller bolt until snug (9b image).



10. Install the volute onto the rear bracket using the three volute screws (10a image). Install the check valve onto the snout of the volute (image 10b). The drive unit should be turned over a few times to check for clearance between the impeller and volute. A small amount of drag between the impeller and volute will cause no problem, however, if the drive unit will not turn over because of the lack of clearance a bracket shim may have to be used.



11. Install the pump body as shown below with the outlet flange facing up. Install the 10 body screws, 10 lock washers, and 10 nuts to secure the pump body to the rear bracket. Tighten the bolts securely all the way around.

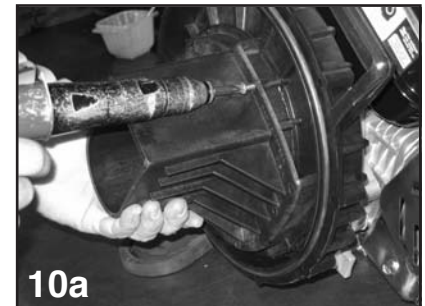

The pump is ready for operation after you have filled the wet seal reservoir 3/4 full (the seal assembly should be submerged) with a 50% ethylene glycol (anti-freeze) and 50% water mixture.

